

# *Asycube mechanical integration guidelines*



<b>Document</b>	Asycube mechanical integration guidelines 000.103.437		
<b>Version</b>	A1	<b>Date</b>	12.02.2021

## Table of contents

<b>1.</b>	<b>INTRODUCTION.....</b>	<b>3</b>
1.1.	GENERAL INFORMATION.....	3
1.2.	DOCUMENT PURPOSE.....	3
1.3.	SYMBOLS.....	3
1.3.1.	<i>Images.....</i>	3
1.3.2.	<i>Acronyms.....</i>	4
<b>2.</b>	<b>ASYCUBE INTEGRATION .....</b>	<b>5</b>
2.1.	ASYCUBE POSITION ON SUPPORT AND SUPPORT CHARACTERISTICS.....	5
2.2.	FIXING THE ASYCUBE ON ITS SUPPORT .....	5
<b>3.</b>	<b>VIBRATION DECOUPLING.....</b>	<b>6</b>
3.1.	DECOUPLING OF MOVING DEVICES .....	6
3.2.	DECOUPLING OF THE CAMERA .....	8
<b>4.</b>	<b>MINIMAL DISTANCE BETWEEN ASYCUBE(S).....</b>	<b>9</b>
<b>5.</b>	<b>TECHNICAL DATA TABLES .....</b>	<b>10</b>
5.1.	SUPPORT CHARACTERISTICS.....	10
5.2.	SCREWS DETAIL .....	10
5.3.	VIBRATION ISOLATORS DETAILS .....	11
5.4.	MINIMAL DISTANCE BETWEEN ASYCUBE(S).....	12

# 1. Introduction

## 1.1. General information

The following document is the property of Asyрил S.A. and may not be copied or circulated without permission. The information contained in this document is subject to change without notice for product improvement purpose. Please read this document carefully to ensure your product correctly integrated and implemented. Nevertheless, should you encounter difficulties, please contact Asyрил customer service.

## 1.2. Document purpose

The main purpose of present document is to make machine manufacturers aware of the different features necessary to ensure the correct integration of the Asycube product and its accessories.

## 1.3. Symbols

Following symbols will be used multiple times in the document.

### 1.3.1. Images



Wrong implementation

---



Correct implementation

---

**ON**

Active / operating feature (moving)

---



Movements



**OFF**

Passive / NOT operating feature (NOT moving)

---



Perturbation / undesired vibration

---

### 1.3.2. Acronyms

<b>APSO</b>	Angst + Pfister – <a href="http://www.apsoparts.com">www.apsoparts.com</a> – (section: Antivibration Technology; APSOVib)
<b>ELESA</b>	Elesa – <a href="http://www.elesa.com">www.elesa.com</a> – (section: Rubber buffers)
<b>A</b>	max. support length for Asycube
<b>B</b>	max. support width for Asycube
<b>c</b>	distance between Asycube(s)
<b>ØD</b>	diameter of the round buffer APSOVib
<b>G</b>	thread diameter
<b>H</b>	height of the round buffer APSOVib
<b>c<sub>z</sub></b>	spring constant of the round buffer APSOVib; compression in Z direction (axial direction)
<b>F<sub>z</sub></b>	max. allowed compressive force of the round buffer APSOVib
<b>L</b>	thread length – male
<b>M</b>	mass (used for Asycube feature definition)
<b>N/A</b>	not applicable
<b>Qty.</b>	quantity
<b>Ref.</b>	reference
<b>s</b>	thread depth – female

## 2. Asycube integration

To ensure good vibration behavior the Asycube must be correctly fixed on a support specifically defined for the application. An incorrect installation of the Asycube could compromise the performances of the product.

### 2.1. Asycube position on support and support characteristics

The Asycube must be fixed either on a rigid support screwed to the ground or on a "free" heavy support. For the second application the mass [M] and the dimensions [AxB] of the support must be large enough to absorb the vibrations generated by the feeder. These mass and dimensions are summarized in: Table 5-1 - *Support characteristics*.

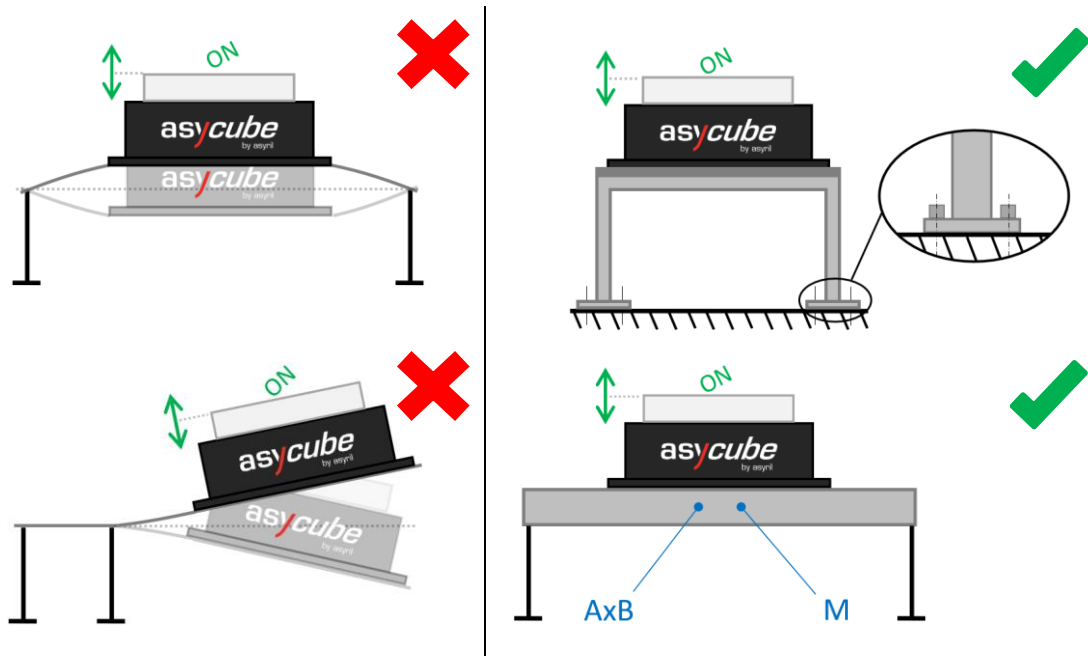

### 2.2. Fixing the Asycube on its support

The Asycube must be properly screwed on the support. The quantity of screws necessary to fix the base plate of the Asycube and the screws dimensions are summarized in: Table 5-2 - *Screws detail*.

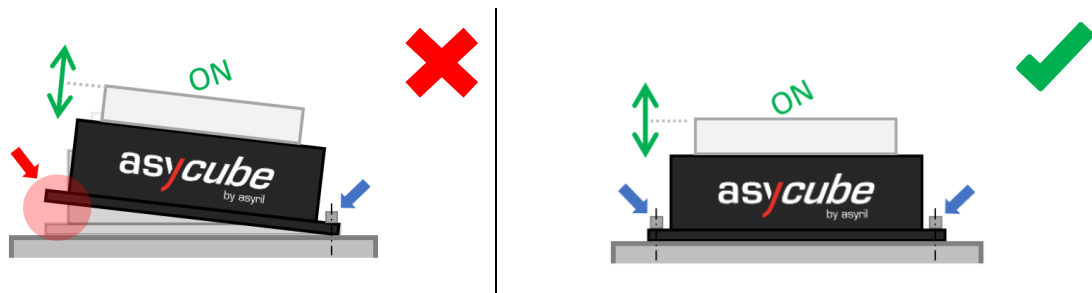

### 3. Vibration decoupling

Incorrect assembly of Asycube(s), camera(s), robot(s) and hopper(s) may compromise final system performance. To ensure the good behavior of a system, it is necessary to avoid that all the involved devices can interfere with each other.

*Note: hoppers provided by Asyriil are already equipped with vibration isolators so that hopper vibration is not transmitted to other peripherals.*

#### 3.1. Decoupling of moving devices

If several moving devices have to be assembled in parallel, and close to each other, it is necessary to "decouple the vibrations", to avoid that behavior of any product is disturbed by the movement of others.

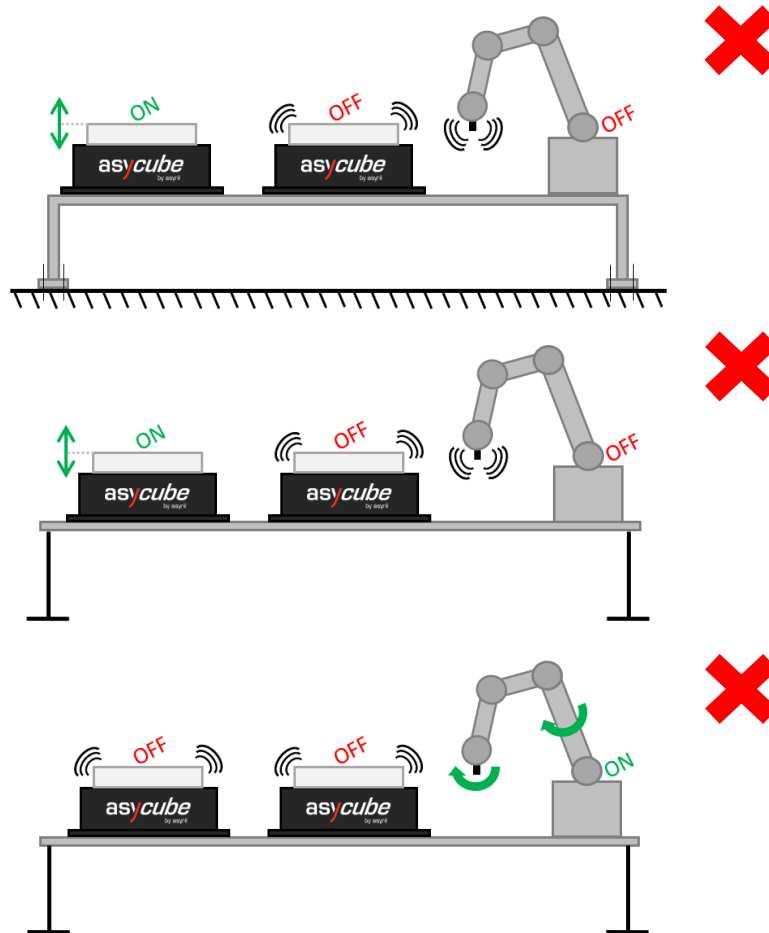

To avoid backfeeding of vibrations it is therefore recommended to provide specific support for each device. When this solution is not applicable, vibration decoupling can be achieved through anti-vibration technologies (e.g. vibration isolators [①]).

*Note: vibration isolators solution is only applicable to Asycube(s) 240, 380 and 530.*

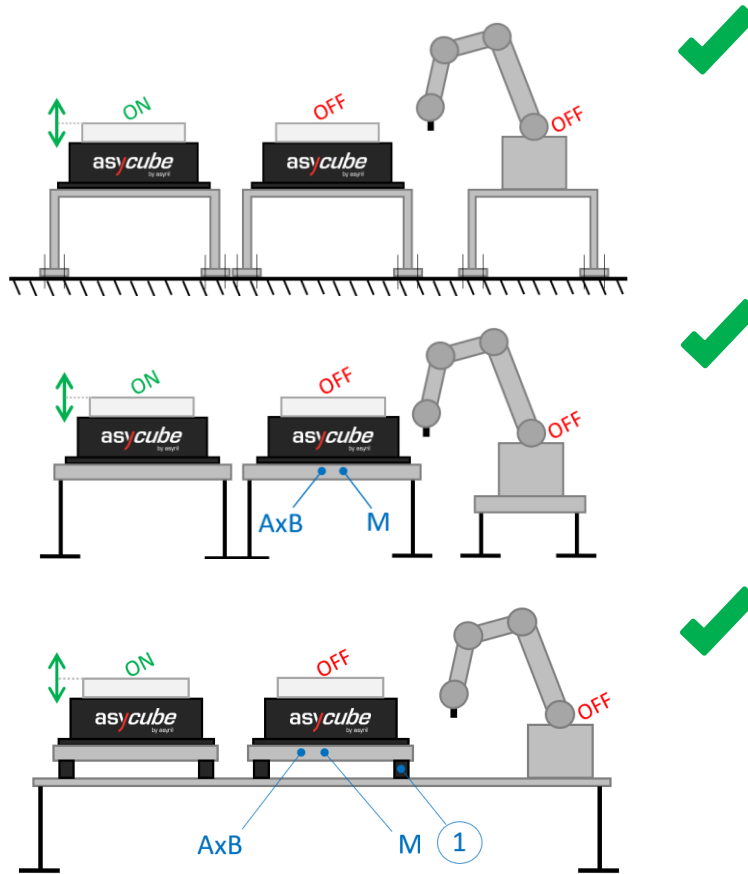

The mass [M] and dimensions [AxB] of the support are summarized in: Table 5-1 - *Support characteristics*.

The vibration isolator [①] details are summarized in: Table 5-3 – *Vibration isolators details*.

*Note: Increase the mass of the base support to avoid the integration of the vibration isolators does not ensure that the spread vibrations will be completely dampen-out.*

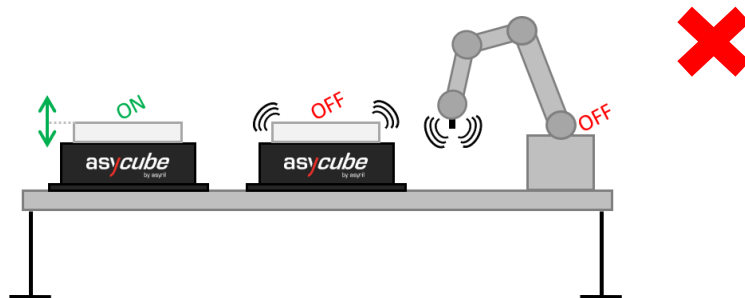

### 3.2. Decoupling of the camera

It is important that the camera is not perturbed by the vibration of Asycube or by any other moving device. If the vision system is “disturbed” by residual vibrations, the coordinates sent to the robot will not be reliable, thus compromising the precision of the whole system. Therefore, it is recommended not to install Asycube(s) and camera on the same support. When this solution is not applicable, be sure to fix the camera on a rigid and heavy enough support to prevent back-feeding of vibrations into surrounding devices.

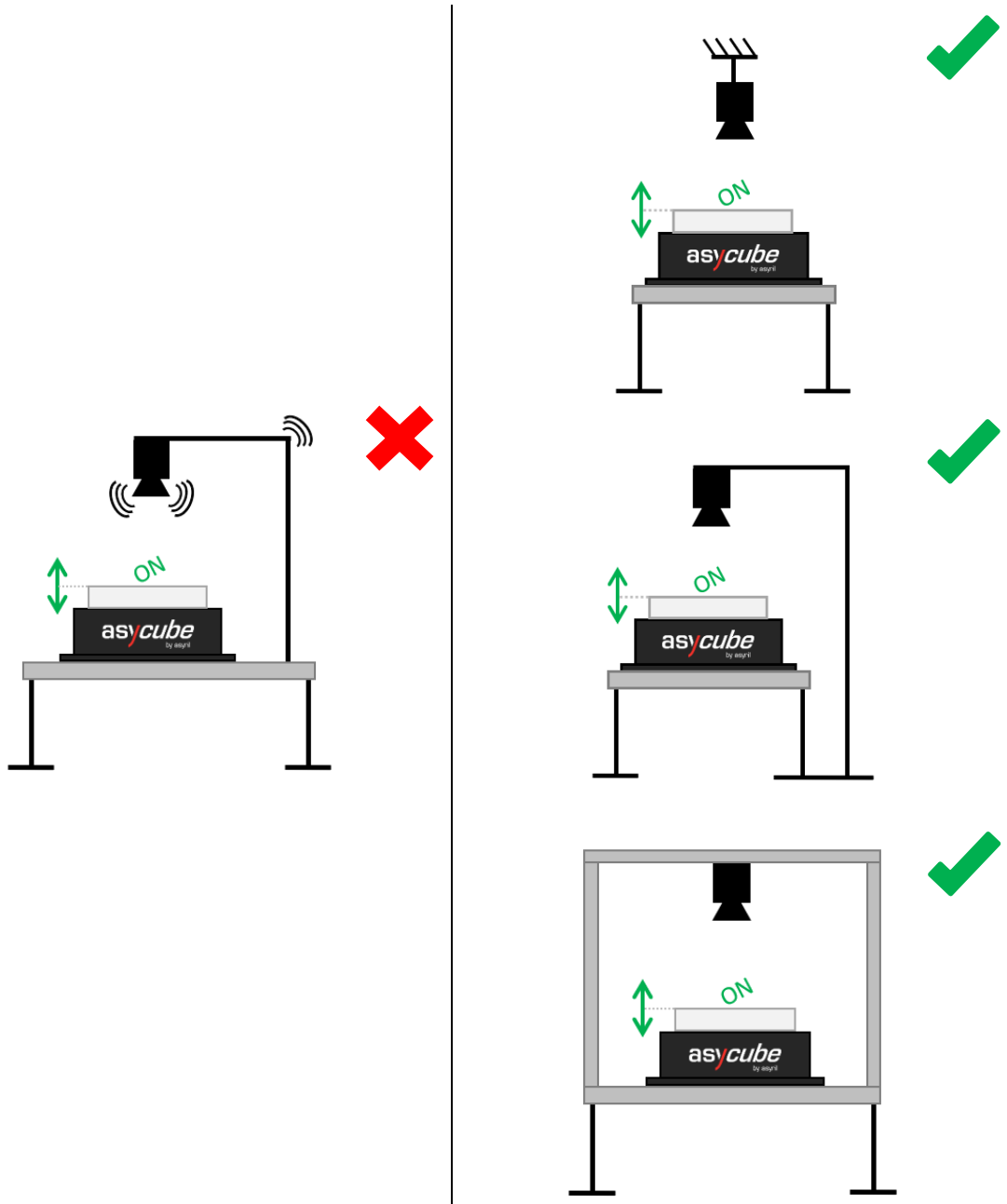



## 4. Minimal distance between Asycube(s)

If two or more Asycube(s) are installed close to each other, the movement of the active device can excite the passive one. It is therefore recommended to install the Asycube(s) at enough distance [c] to prevent them from disturbing each other.

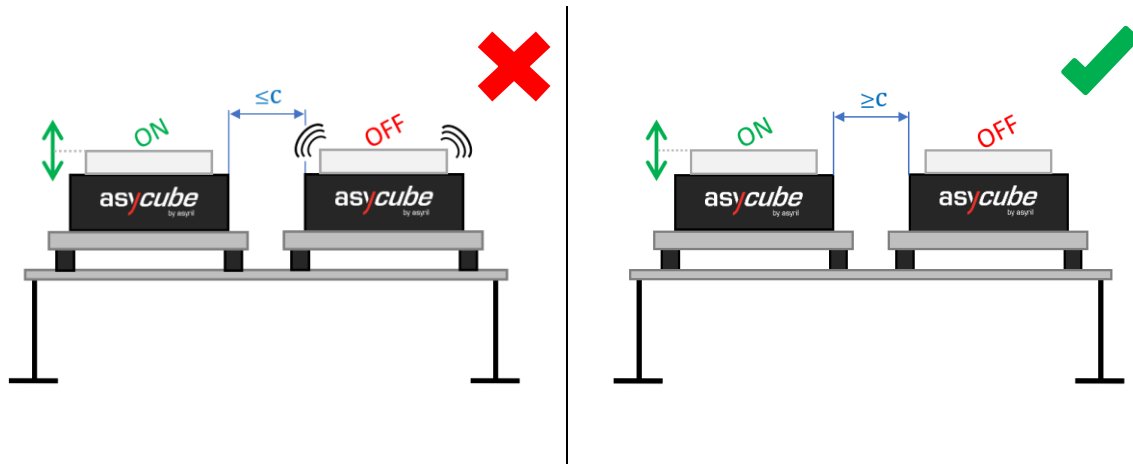

The minimal distance [c] between Asycube(s) is summarized in: Table 5-4 - *Distance between Asycube(s)*.

## 5. Technical data tables

This chapter contains the technical parameters necessary to correctly install Asycube products.

### 5.1. Support Characteristics

Asycube	50	80	240	380	530
M – [Kg]	≥ 10	≥ 10	≥ 40	≥ 200	≥ 250
A – [mm]	≤ 600	≤ 600	≤ 600	≤ 1000	≤ 1200
B – [mm]	≤ 150	≤ 150	≤ 350	≤ 500	≤ 750

Table 5-1 - Support characteristics

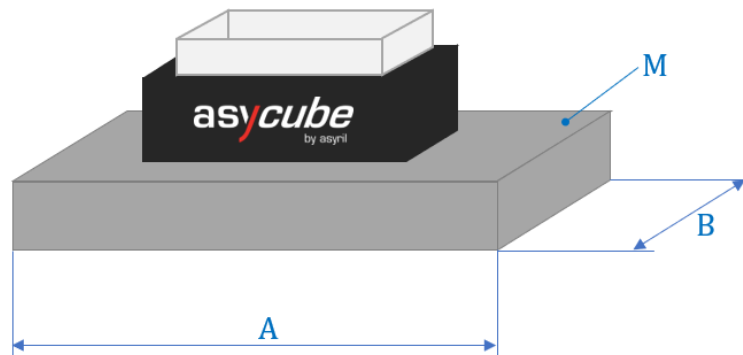

*Note: The thickness of the support must be calculated basing on requirements resumed in Table 5-1 - Support characteristics.*

*Make sure that the minimal mass [M] requirement is respected.*

### 5.2. Screws detail

Asycube	50	80	240	380	530
Qty. of screws	2	4	4	4	4
Screw Ø	M5	M5	M6	M8	M8

Table 5-2 - Screws detail

### 5.3. Vibration isolators details

① – Vibration isolator (Round / Rubber buffers)			
Recommended for:	Asycube 240	Asycube 380	Asycube 530
APSO Ref. *1	12.2034.0103	12.2034.0293	12.2034.0353
ØD – [mm]	16	40	50
H – [mm]	20	40	50
G – [mm]	M5	M8	M10
L – [mm]	12	25	25
s – [mm]	3	8	10
c <sub>z</sub> – [N/mm]	50	180	190
F <sub>z</sub> – [N]	120	690	1000
Qty. – [-]	4	4	4
ELESA Ref. *2	411771 DVA.2-15-20-M4-10-55	412021 DVA.2-50-45-M10-28-55	
ØD – [mm]	15	50	
H – [mm]	20	45	
G – [mm]	M4	M10	
L – [mm]	10	28	
s – [mm]	4	10	
c <sub>z</sub> – [N/mm]	47	182	
F <sub>z</sub> – [N]	234	2046	
Qty. – [-]	4	4	

**Table 5-3 – Vibration isolators details**

Vibration isolator (round buffer) details:

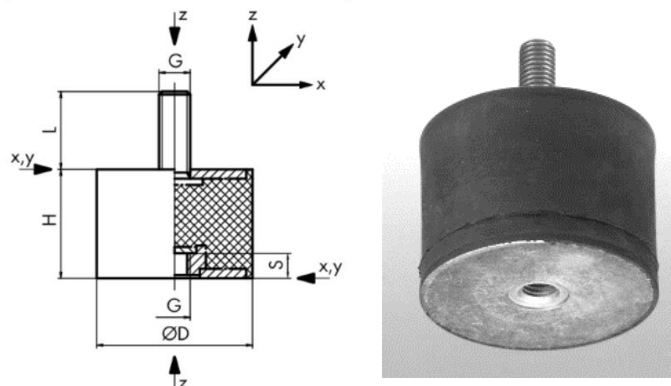

\*1 Angst + Pfister – [www.apsoparts.com](http://www.apsoparts.com) – (section: Antivibration Technology; APSOVib)

\*2 Elesa – [www.elesa.com](http://www.elesa.com) – (section: Rubber buffers)

Attention:



Make sure that total mass of Asycube, support and components will not exceed the max. allowed compressive force of the round buffers [F<sub>z</sub>]. If this scenario occurs new round buffers must be selected.

Vibration isolator (round buffer) positioning:

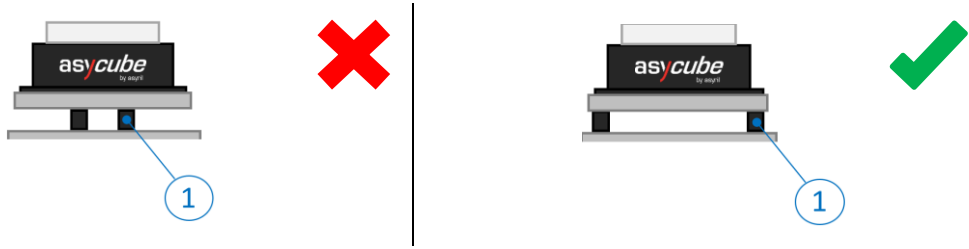

**5.4. Minimal distance between Asycube(s)**

Asycube	50	80	240	380	530
c – [mm]	≥ 10	≥ 10	≥ 10	≥ 30	≥ 30

Table 5-4 - Distance between Asycube(s)

## Revisions:

Rev.	Date	Author	Comments
A	22.01.2020	SoD	First version
A1	12.02.2021	SoD	Added 2 <sup>nd</sup> option for vibration isolator §1.3.2 / §5.3

This document is the property of Asyrl S.A. and may not be copied or circulated without permission. The information contained in this document is subject to change without notice for the purpose of product improvement.



asyrl sa  
z.i. le vivier 22  
ch-1690 Villaz-st-pierre  
Suisse  
tél. +41 26 653 71 90  
[info@asyrl.com](mailto:info@asyrl.com)  
[www.asyrl.com](http://www.asyrl.com)